

FLAT LED PROJECTOR FOR SWIMMING POOL – WHITE LIGHTING



Model : **502860**
 Type : 60 LED 2835 / 120°
 Color : white 6500K
 Control : On/Off
 Functions : N/A
 Material : Fixture and lens in polycarbonate (PC), ring in ASA
 1,5" thread to screw in vacuum fitting
 Wire connection : 2 screw terminals
 2 meters HO7RNF wire 2x1,5mm²
 HS code : 9405403990
 Bar code : 3700450502860

Contents of the packaging :

- Flat LED Projector
 - 1 white crown (#501672)
 - 2 heat shrinkable connectors (#501696)
 - 2 gaskets (#501917)
 - 1 H07RNF cable 2x1,5mm² (#500903)
 - Inground pool installation kit (#501368)
 - 5 nylon screws (PA) (#501900)
 - Usage and maintenance manual
- Option :**
- Above ground pool installation kit (#501009)



DIMENSIONS

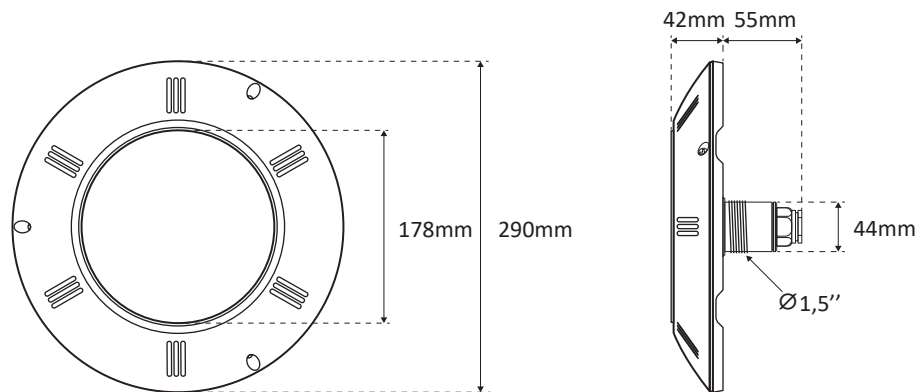

PACKING

Part Number	Box	Weight	Size	Carton	Weight	Size	Pallet	Weight	Size
502860	1U	1,62kg	30x30x11,5cm	5U	8,1kg	60x32x32cm	180U	316kg	100x120x207cm

CONNECTION

Use a 2 x 1mm² minimum cross section of connecting cable, to adapt according to the distance between the junction box of the projector and the transformer well as the power input.



~12V(AC)
or ~20V(DC)

USE ONLY WITH A SAFETY TRANSFORMER / DO NOT PLUG IN SERIES /
PROTECT THE CONNECTOR WITH INSULATING GEL

PHOTOMETRY

(Measurements performed in laboratory; * measurements made in water immersion)

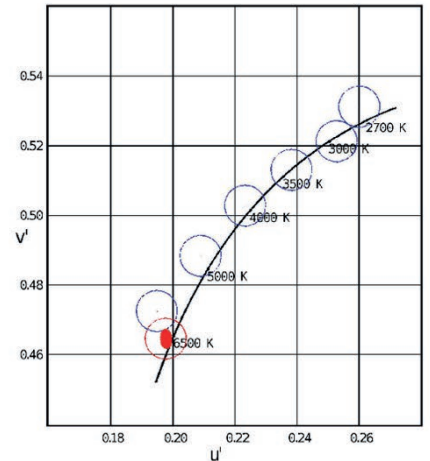
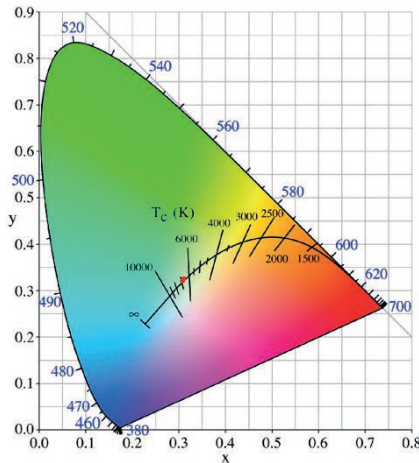
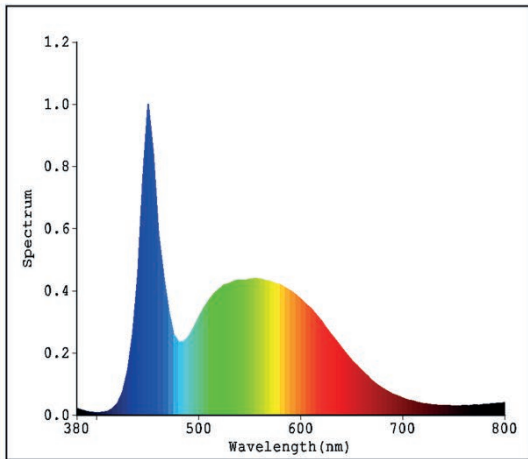





Color temperature : white 6500K
 Ra (IRC) : 86*
 Diffusion angle : 120°
 Nominal luminous flux: 1650 lumens*
 Useful luminous flux (angle 120°) : 1450 lumens*

ELECTRICAL PARAMETERS

Max instant power : 13,50W*
 Stabilized power >1h : 13,50W*
 Power voltage : ~12V(AC) 50/60Hz or ~20V(DC)
 PF max : 0,7 si ~12V(AC)
 PF max : 1 si ~20V(DC)
 Mini power supply ~12V(AC) [(Pi / PF)+20%] : 23VA
 Electrical Class : III
 EEI : 0,14





CLASS III  ~12V(AC)
 ~20V(DC)

OTHER PARAMETERS

Protection index : IP68*
 LED life span: > 10 000h
 On/Off Cycles : > 100 000
 Use : permanent under water use only



>100 000



USE ONLY IN OUTDOOR POOL
 LAMP NOT SUITABLE FOR
 ACCENT LIGHTING

Hg
0,0mg

IP68  **1,0m**

CERTIFICATION

EMC 2014/30/EU Directive.
 EN60598-1 / EN60598-2-18 Norm in all its modifications.





Products
Certified by



TÜVRheinland

GRUPO



EN62471 : 2008



ENERGY Y IJA
IE IA
енергия · ενεργεια

This luminaire includes integrated LED lamps

A++

A+

A

B

C

D

E

}

LED

Lamps in this luminaire can not be changed

13,5 kWh/1000h